

# Layher Allround Scaffolding the multitalented system for building sites



Allround® Scaffolding

Layher® 

More Possibilities. The Scaffolding System.

# Layher

## Your dependable partner for building sites

Layher has been a source of innovation, top quality and profitability for more than 60 years now. Layher scaffolding is flexible to use, quick to assemble and offers lasting value thanks to the long service life of all components.

Layher scaffolding systems are suitable for an unbeatable variety of uses – primarily on construction sites but also in industry and at events.

The wide range of Layher products, their design as modular systems and their cross-system compatibility enable you to cope with every application you can think of. This consistent focus on the demands of practical use ensures our products have a flexible and economical basis.

For more than six decades now the company has had its sole production and design facility in Eibensbach. Made by Layher means Made in Germany.

Layher quality sets standards. Certified to DIN ISO 9001:2000, streamlined and automated production ensures consistent high quality. Dependable suppliers, selected materials and strict quality controls at every phase of production are a matter of course for us, as are the marking and documenting all Layher parts to enable them to be traced.

Because we maintain high stocks and operate a flexible production system, we can offer unique delivery capability. With a very well equipped service and delivery

network of over 30 branches and delivery warehouses in Germany, a fast delivery service plus more than 25 sales subsidiaries and many more trading partners worldwide, we ensure that you can obtain our products any time and anywhere.

You too can benefit from our decades of experience and from the inventive spirit and skills of our employees. Layher scaffolding guarantees your success. Choosing Layher means choosing partnership, efficiency and profitability. We will keep on proving that in scaffolding construction there are still many “more possibilities”. Welcome to the world of successful construction companies.

*Company headquarters and production site at Gueglingen-Eibensbach*



# Contents

<b>Allround scaffolding system</b>	4
<b>Allround scaffolding system basic components</b>	5
<b>Support scaffolding</b>	6
<b>Concreting scaffolding and reinforcing scaffolding</b>	8
<b>Façade scaffolding</b>	10
<b>Birdcage scaffolding</b>	12
<b>Stairway access</b>	14
<b>Mobile work scaffolding</b>	16
<b>Trench and emergency bridges</b>	18
<b>Further applications</b>	20
<b>Storage and transport</b>	23

For further literature: technical brochures, instructions for assembly and use, structural strength verifications, user manual etc. please contact us.

*Central warehouse, Gueglingen-Eibensbach*



# Layher Allround Scaffolding - the "Original"

## Ingenious technology for efficient work

Strong and inexpensive (hot-dip galvanised) steel Allround scaffolding is primarily used for elaborate and ambitious scaffolding.

The advantage of the aluminium Allround scaffolding, which is identical in design, is its low weight and its suitability for applications where appearance is relevant or where steel is not permitted.

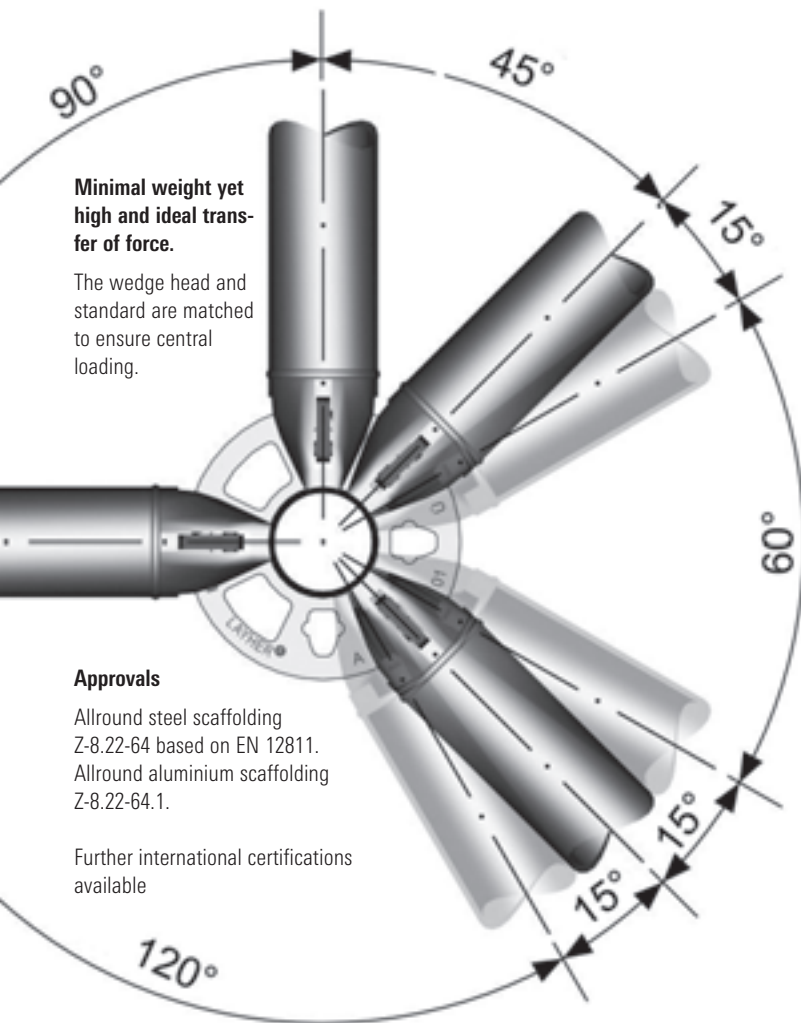

Allround scaffolding uses a simple, unique and bolt-free connection technology.

Sliding the wedge head over the rosette and inserting the wedge into the opening immediately secures the component. There is still sufficient play to secure the other end of the ledger.

A hammer blow to the wedge transforms the loose connection into a superbly strong structurally rigid one. The face of the wedge head is now precisely positioned against the standard.

The result of superior design:

Up to 8 connections can be made in the structurally ideal Allround connector on one level and at various angles. Connections are provided in standard dimensions of 50 cm on all Allround standards. The flat rosette prevents clogging with dirt of whatever type.

Ingenious connection technology:

The four small punched-out openings in the rosette automatically centre the ledger at right angles – the four large openings allow the angle of alignment to be selected.

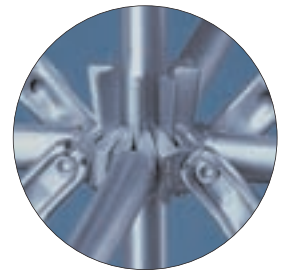

- Your benefit**
- ▶ Save time during assembly and dismantling thanks to bolt-free connection technology
  - ▶ Safe and simple one-man assembly
  - ▶ No loose parts
  - ▶ Very little material required

- ▶ Maintenance free and always ready for use
- ▶ Low weight of individual parts
- ▶ Tried and proven range of parts
- ▶ Economic and versatile design that convinces

# Layher Allround Scaffolding

## Basic components

You have a modular system for nearly all conceivable applications, using just a few basic components. For specific applications we can supply a large number of additional efficient system solutions.

Safety is very important at Layher. The Layher advance guardrail (AGR) takes this into account right from the time the scaffolding is assembled. The AGR consists of advance guardrail posts and telescopic guardrails. The person erecting

the scaffolding can easily move the advance guardrail posts up or down using the blue twist grips.

Tested connection points are provided for the rope safety gear.

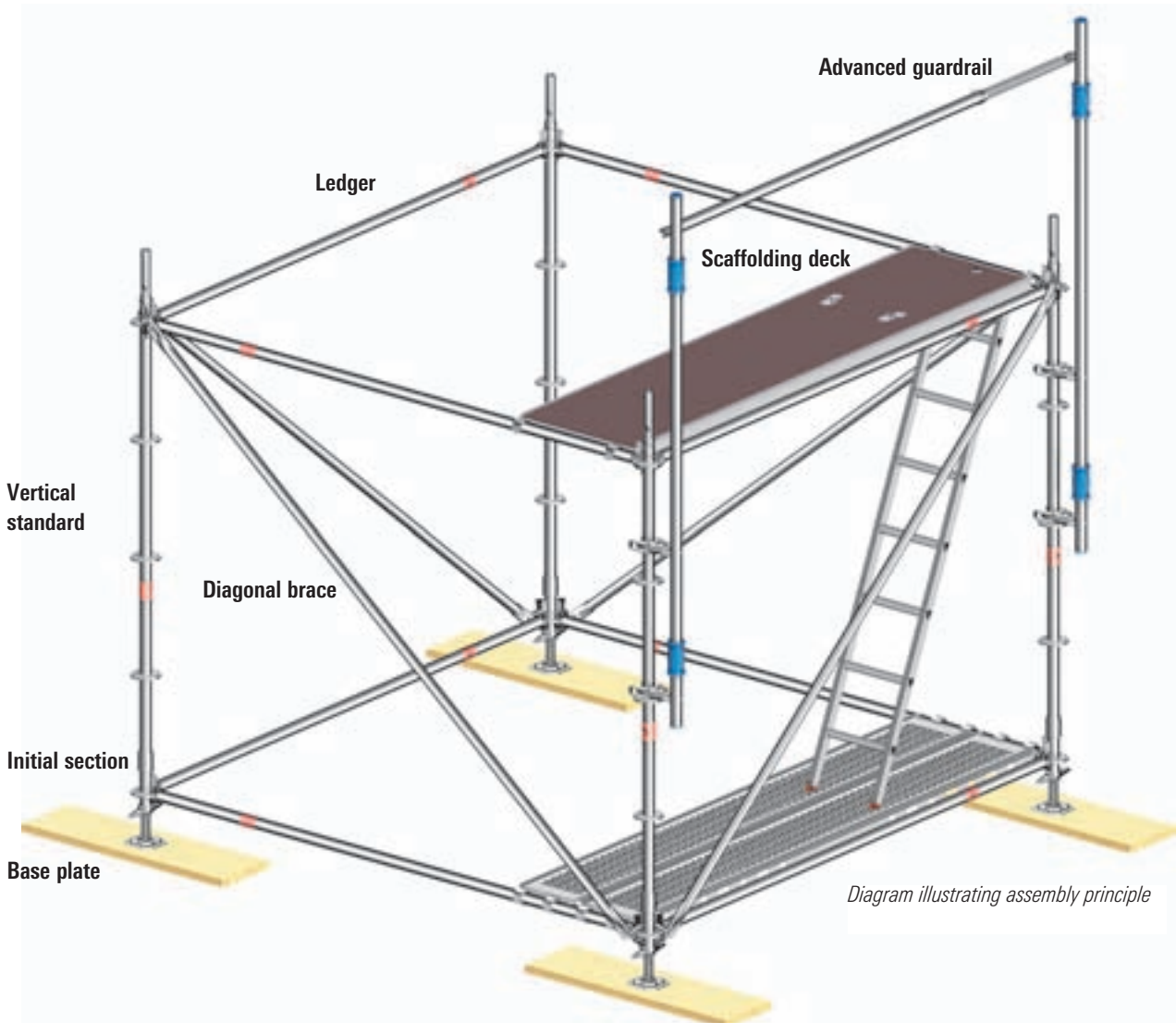

### Decks for mounting on U-ledgers

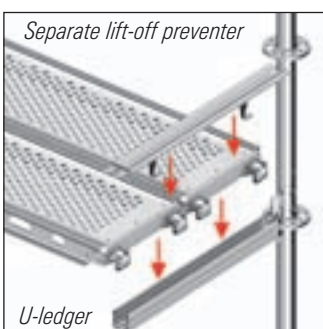

### Decks for mounting on O-ledgers

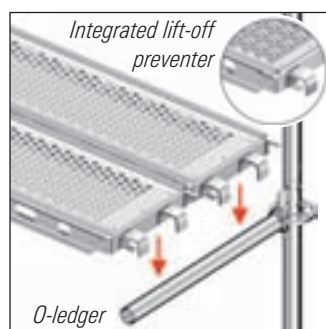

### One system – Two variants

Choose the variant that is most suitable for your purpose, thus ensuring that you work as efficiently as possible. On Layher Allround scaffolding with U-ledgers and U-decks the claws of two decks are both secured by one lift-off preventer. Lift-off preventers are incorporated in the base of the decks on versions with O-ledgers.



## Layher Allround Scaffolding

### Economic support scaffolding

Layher Allround scaffolding can accommodate all types of high loads and is the ideal system for all kinds of support scaffolding. Thanks to its versatility, you can adapt the scaffolding to the conditions on site.

Variable spacing for the standards ensures that the design of the support scaffolding can be optimally matched to the existing load and the falsework system in each case.

Heavy-duty towers made of bundled standards can carry loads of up to 60 t. Extensive structural strength calculations and technical user documents are available.

Allround scaffolding has an efficient solution to deal with all challenges, regardless of whether they involve ceiling falsework at a great height, barrel vaults or round inner scaffolding. Heavy steel beams can easily be supported with the help of a top spindle.

Projections, working platforms and fall arrest levels can easily be mounted using existing basic components. Here the rosette spacing of 50 cm provides the basis for an extremely versatile scaffolding system.

Safety and efficiency will work in your favour.

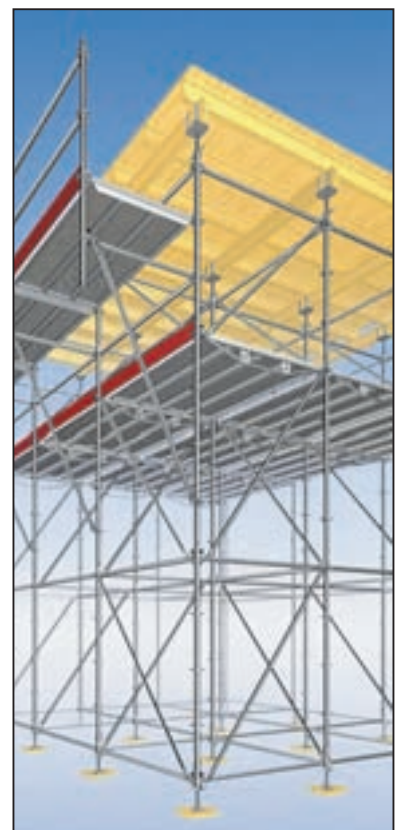

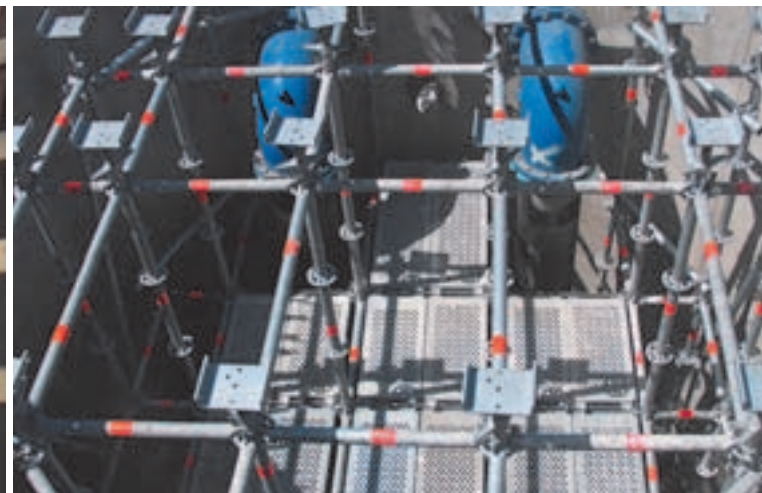

## Your benefit

- ▶ Optimum adaptation to the ground shape
- ▶ You can cope with maximum loads using a minimum of material
- ▶ Thanks to a simple combination of standard components you can also cope with the greatest challenges in terms of flexibility and assembly speed
- ▶ Extremely accurate fit thanks to certified high-quality manufacture. As the outlay required for maintenance is minimal, the equipment is always available and therefore allows you to operate more profitably
- ▶ Tested connection mechanisms provide you with a high degree of safety





## Layher Allround Scaffolding Scaffolding for formworkers and steelfixers

Unimpeded access to the wall and beam reinforcement is provided without wall ties. Stability is achieved through simple support and, if required, by widening the base.

Suitable bay lengths ensure that access is provided to all relevant components. Inner guardrails and brackets create safe working conditions where there is a large gap to the wall. The width of the scaffolding can be adapted to the amount of space available. The fact that the advance guardrail is fitted to both sides of the scaffolding provides a high level of safety even during erection.

Thanks to the use of pull-resistant pins to connect the standard joints, the scaffolding can be moved at any time using a crane.

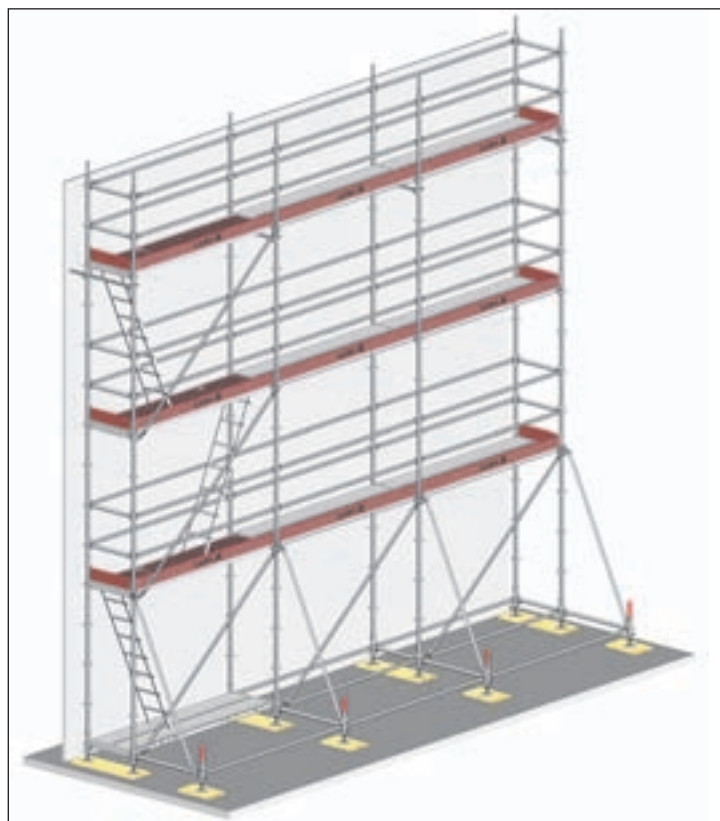





## Your benefit

- ▶ You have various system solutions available to achieve stability, even without wall ties
- ▶ You can carry out operations in relation to formwork, reinforcing and concreting using the same scaffolding
- ▶ It is possible to work freely on the Allround system, without an inner standard at the top level
- ▶ The system can be moved by crane, saving time during assembly and dismantling



## Layher Allround Scaffolding

### Façade scaffolding

With its superlative adaptability Allround scaffolding is the obvious choice for very irregular façades. The advantages of Allround scaffolding really come to the fore when the building has projections, recesses, cantilevers and niches.

With Allround scaffolding all tasks can be carried out extremely efficiently. Allround meets many different requirements at the same time, acting as a work and protective scaffolding for bricklayers, concrete workers, carpenters, plumbers, roofers, plasterers and painters.

Allround scaffolding has been granted building authority approval as façade scaffolding by the Deutsches Institut für Bautechnik under Z-8.22-64. Where the configuration requirements differ from the standard assembly, structural strength verifications are quickly available, thus ensuring that erection is not delayed.





## Your benefit

- ▶ The fact that the standard version has been certified and that verifications of scaffolding stability are available make technical planning easier
- ▶ Depending on requirements, the advance guardrail can be fitted alongside the scaffolding, on both the **outside** and the **inside**, providing maximum safety at all times
- ▶ All Layher systems are compatible with one another. A large number of accessories are therefore available for different applications
- ▶ Variable adaptation to working height
- ▶ The Allround system allows scaffolding structures to be erected with decks only at working levels. This saves a considerable amount of material when compared to frame scaffolding



## Layher Allround Scaffolding Birdcage scaffolds

Birdcage scaffolding is used for applications that range from small Allround scaffolding towers to extensive accesses under ceilings or bridges. They are used for both stationary and mobile applications. This means that only a few scaffolding bays have to be fitted out with decks. These can be added and removed, as required, even after the scaffolding has been completed.

You can accommodate the client's requirements and the site situation by using the appropriate combination of bay lengths. This will allow you to get around obstacles.

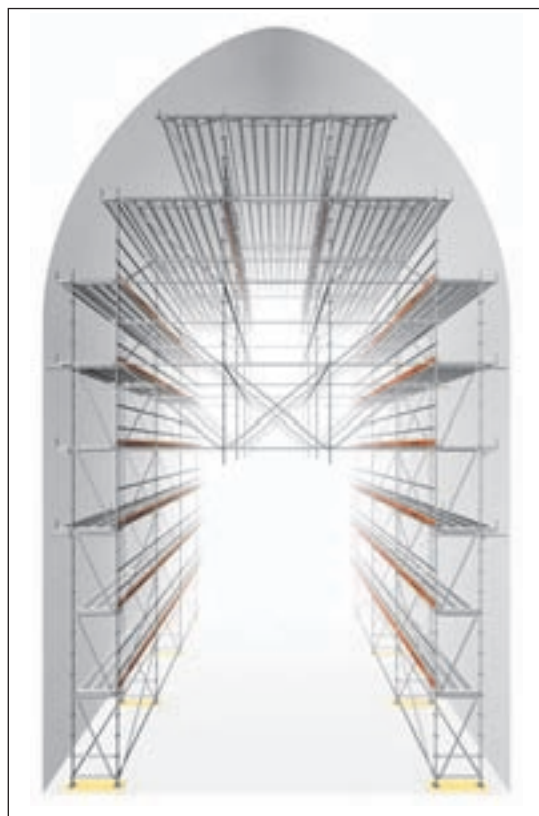

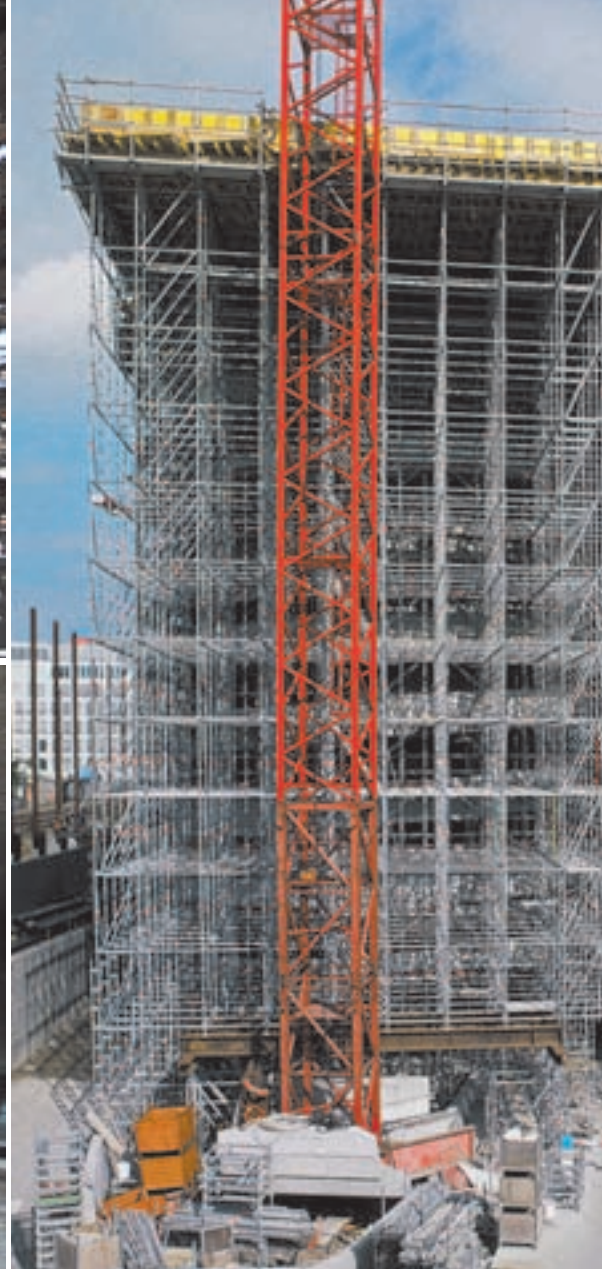

## Your benefit

- ▶ Whether rectangular or not, adaptation to the specified contours of the structure can be achieved at any time thanks to the ingenious Allround rosette
- ▶ After the base has been levelled, the construction is automatically squared. No further levelling is required
- ▶ Decks only have to be installed where they are required
- ▶ A huge number of building tasks can be carried out using only a few standard parts arranged in a changing sequence of new configurations. An extensive range of accessories is available for special requirements
- ▶ Complicated adjustments and improvising are no longer required. This makes for extremely profitable and effective work



## Layher Allround Scaffolding Stairway access

Layher has a suitable solution for all your access needs. Access decks with and without integrated ladders are suitable for internal access. The lightweight aluminium platform stair allows ease of movement between levels and is quickly assembled.

Stairway towers for a broad spectrum of applications and requirements round off the range of access solutions.

The compact stairtower is designed as a construction stairway when building multi family housing.

Construction stairways and stairway towers can be used in parallel or dog-leg configurations.

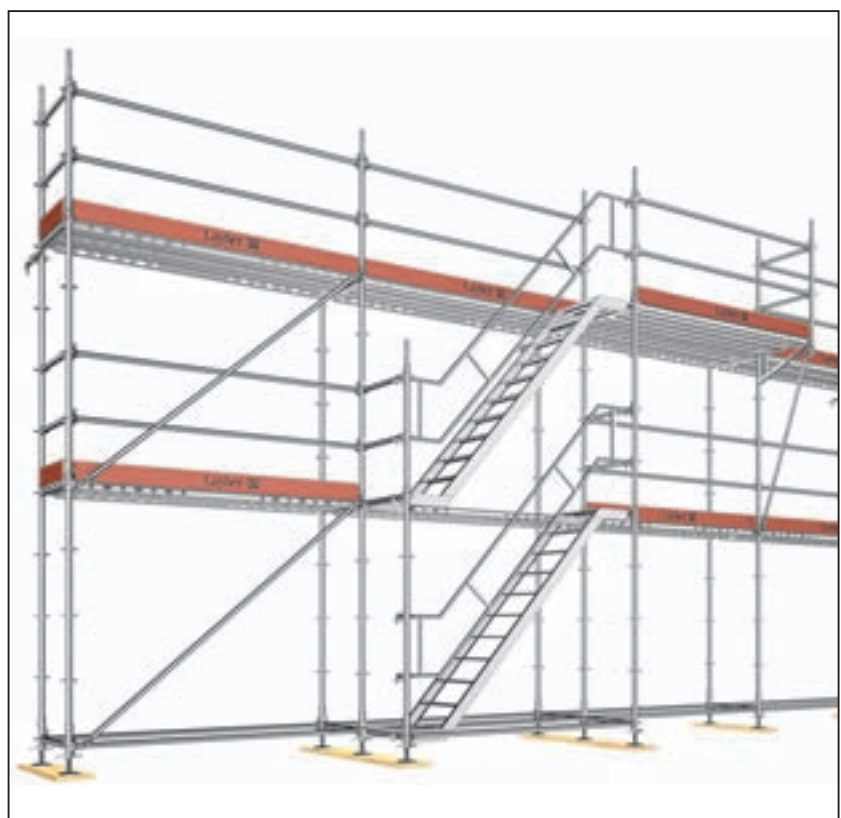



### Your benefit

- ▶ Extensive range of access solutions for every requirement
- ▶ Optimum adaptation to each storey and exit height
- ▶ Simpler and faster to erect with only a few additional parts
- ▶ The appropriate access solution that complies with regulations for every situation
- ▶ Workers, building owners and architects can visit the construction site safely and with minimum effort





## Layher Allround Scaffolding

### Mobile work scaffolding

Mobile scaffolding provides a crucial advantage if work has to be performed section by section. Wheels – ranging from castors with different load bearing capability to rail-guided flanged wheels – are used on mobile scaffolding designs for different applications.

The appropriate choice of base width and ballast leads to lightweight structures.

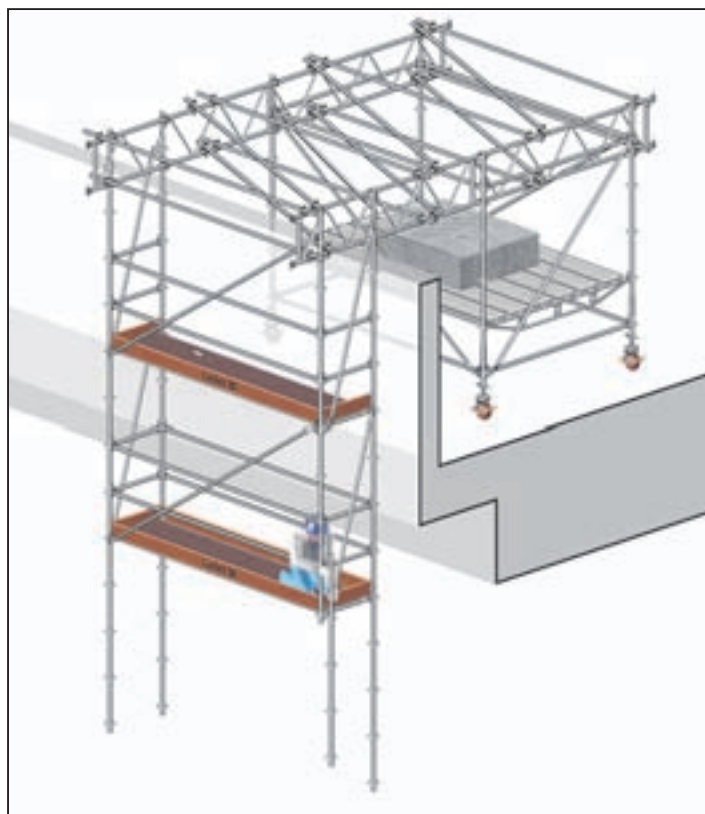



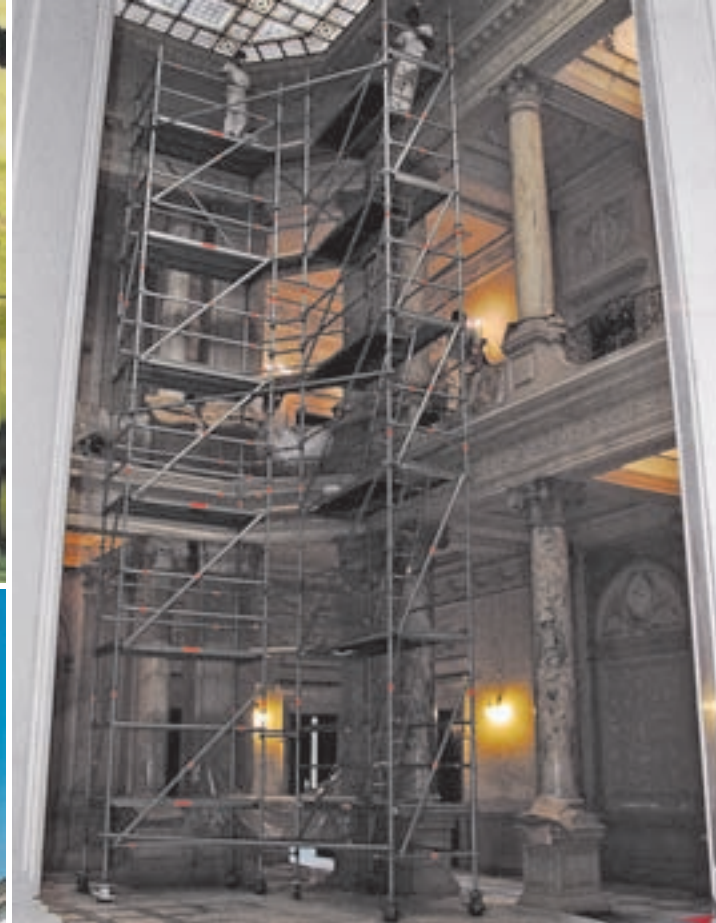
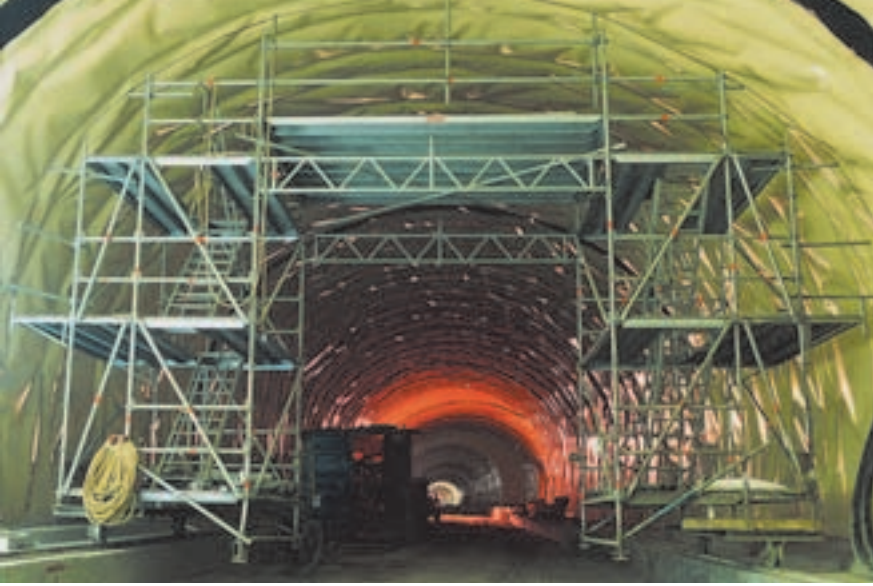

## Your benefit

- ▶ Allround modular scaffolding provides the basis for unmatched economical work to the highest safety standards
- ▶ The finished scaffold can be moved to where it is to be used without technical aids
- ▶ Optimised use of material and fast assembly enhances effectiveness
- ▶ Repeated assembly and dismantling is no longer required
- ▶ Convenient working, freedom of movement, tools and materials moved at the same time



## Layher Allround Scaffolding Trenches and emergency bridges

Temporary links can be created quickly by assembling the bridge on one side and swinging it into position by crane. Access to the unfinished building over excavations or an emergency bridge over streams and rivers only requires standard parts and steel decks. You determine the width of the span by deciding on the number and length of bays.

A free projection at the front is possible if certain prerequisites are fulfilled.





## Your benefit

- ▶ Highly efficient solutions for emergency bridges made of available standard materials
- ▶ Structural calculations for a wide range of standard applications are available
- ▶ Easy to assemble because the structure is self-bracing
- ▶ System lengths can be combined to produce the required width and length
- ▶ Can be pre-fabricated and installed by crane

# Layher Allround Scaffolding

## Further applications



There are a large number of tasks on building sites that can be carried out very quickly with Allround scaffolding. One such task, which is now occurring more frequently, is the erection of cable bridges over access routes.

### Cable bridges



When working on flat roofs it is essential to have effective fall protection fixtures in place. Layher's flat roof side protection takes the special design features of flat roofs into account. You simply have to adjust it to the fascia and install it around structures such as chimneys or skylights. The supports can be lifted one by one to permit work on the roof surface.

### Flat roof side protection



## Construction and advertising signs

Structures for advertising signs to meet different specifications can be assembled quickly. It is easy to adapt the sign to the terrain. The structure can be stabilised using ballast or by installing a base, depending on site conditions. Either temporary or permanent fixtures are possible.

System solutions that are well thought out enhance the appearance of the construction site or storage area. Speed of assembly leads to an economic solution for structures used repeatedly.





## Protection of the environment



Measures to prevent noise pollution and the spread of dust are required more and more often, whether at events or at building sites in urban areas.

The Layher **Protect System** is the obvious choice for this task. It blends in with the neighbouring façades.

The **Protect System** even serves to meet the high requirements stipulated when removing asbestos.

Allround scaffolding acts as a supporting structure for all these applications.

# Layher Allround Scaffolding

## Storage and transport



Layher pallets save on labour and costs for storage, transport, assembly and inventory control. All pallet types have been developed on the basis of practical experience. Loaded pallets can be moved using a crane or a fork-lift truck. They can be stacked on top of each other and save storage and transport space.

All system components can be transported using scaffolding pallets. Tube pallets with box inserts are most suitable for small parts. Empty pallets, stored in the base frame with pallet posts, only require a very small amount of space.



We're there for you. Wherever and whenever you need us.

## Layher in Germany

Branches and delivery warehouses nationwide.

## Layher International

### Subsidiaries:

Argentina, Australia, Austria, Belgium, Bulgaria, Chile, Colombia, France, Hungary, Italy, Lithuania, The Netherlands, New Zealand, Norway, Poland, Peru, Russia, Singapore, Spain, Sweden, Switzerland, United Kingdom, USA.

### Representatives:

Croatia, Czech Republic, Denmark, Estonia, Finland, Hong Kong, Japan, Jordan, Kuwait, Latvija, Lebanon, Libya, Oman, Philippines, Romania, Saudi-Arabia, Serbia, Slovakia, Slovenia, South Africa, Ukraine, United Arab Emirates and many other countries.

## Wilhelm Layher GmbH & Co. KG

Scaffolding Grandstands Ladders

Post Box 40  
74361 Gueglingen-Eibensbach  
Germany  
Phone +49 71 35 70-0  
Fax +49 71 35 70-372  
E-mail [export@layher.com](mailto:export@layher.com)  
[www.layher.com](http://www.layher.com)

## The Layher Product Range

