

## LAYHER ALLROUND SCAFFOLDING® LAYHER STAR FRAME

Edition 04.2013  
Ref. No. 8116.202

Quality management  
certified according to  
ISO 9001:2008  
by German TÜV-CERT



# LAYHER ALLROUND SCAFFOLDING® – THE “ORIGINAL”

// A SYSTEM WITHOUT LIMITS



**Allround Scaffolding uses a simple, unique and bolt-free connection technology.** Sliding the wedge head over the rosette and inserting the wedge into the opening immediately secures the component. There is still sufficient play to secure the other end of the ledger.



A hammer blow to the wedge transforms the loose connection into a strong structurally rigid one. The face of the wedge head is now precisely positioned against the standard.



**The result of superior design.**

Up to 8 connections can be made in the structurally ideal Allround connector on one level and at various angles. Connections are provided in standard dimensions of 50 cm on all Allround standards. The flat rosette prevents clogging with dirt of whatever type.



**Ingenious connection technology.**

The four small punched-out openings in the rosette automatically centre the ledger at right angles – the four large openings allow the angle of alignment to be selected.

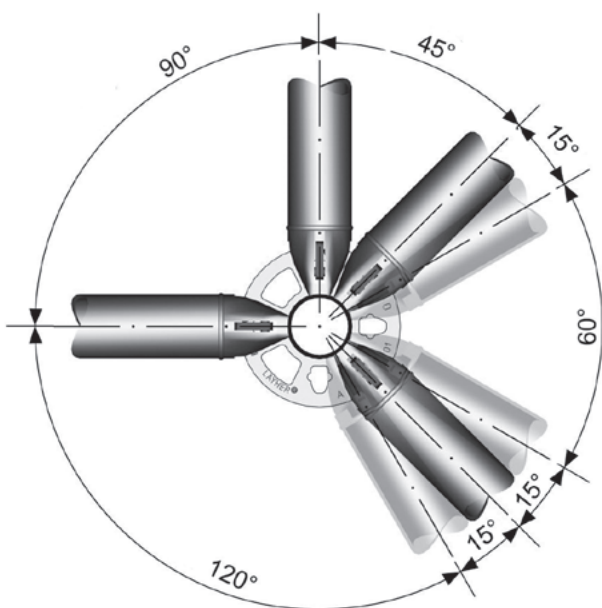

**Minimal weight yet high and ideal transfer of force.** The wedge head and standard are matched to ensure central loading. **Approvals:** Allround steel scaffolding Z-8.22-64 based on EN 12811. Allround aluminium scaffolding Z-8.22-64.1. Further international certifications available.

**Ingenious technology for efficient working.**

The main use of the sturdy and inexpensive Allround equipment in (hot-dip galvanized) steel is in construction and industry, especially for ambitious projects.

**THE BENEFITS TO YOU**

- ▶ Save time during assembly and dismantling thanks to bolt-free connection technology.
- ▶ Safe and simple one-man assembly.
- ▶ No loose parts.
- ▶ Very little material required.
- ▶ Maintenance free and always ready for use.
- ▶ Low weight of individual parts.
- ▶ Tried and proven range of parts.
- ▶ Economic and versatile design that convinces.

# LAYHER STAR FRAME – THE “EXPANSION”

// EVEN MORE POSSIBILITIES



Perfect **compatibility** with the **Allround system** and with other Layher product groups.

**Revolutionary**, the new **guardrail attachment** – rapid assembly and dismantling **without tools** and increased safety thanks to it being clearly visible whether the red lever is closed or not.



## STAR frames – even more possibilities in Allround Scaffolding.

The new Layher STAR frame, in U- and O-versions, has been developed on the basis of Allround. With just two additional parts: STAR frame and STAR guardrails, you can build façade scaffolding 24 % faster than with Allround standards and ledgers.

### THE BENEFITS TO YOU

- ▶ Only two main expansion components needed for Allround.
- ▶ Even lower weight.
- ▶ Fast guardrail assembly and dismantling without tools.
- ▶ Decks not needed at every level.

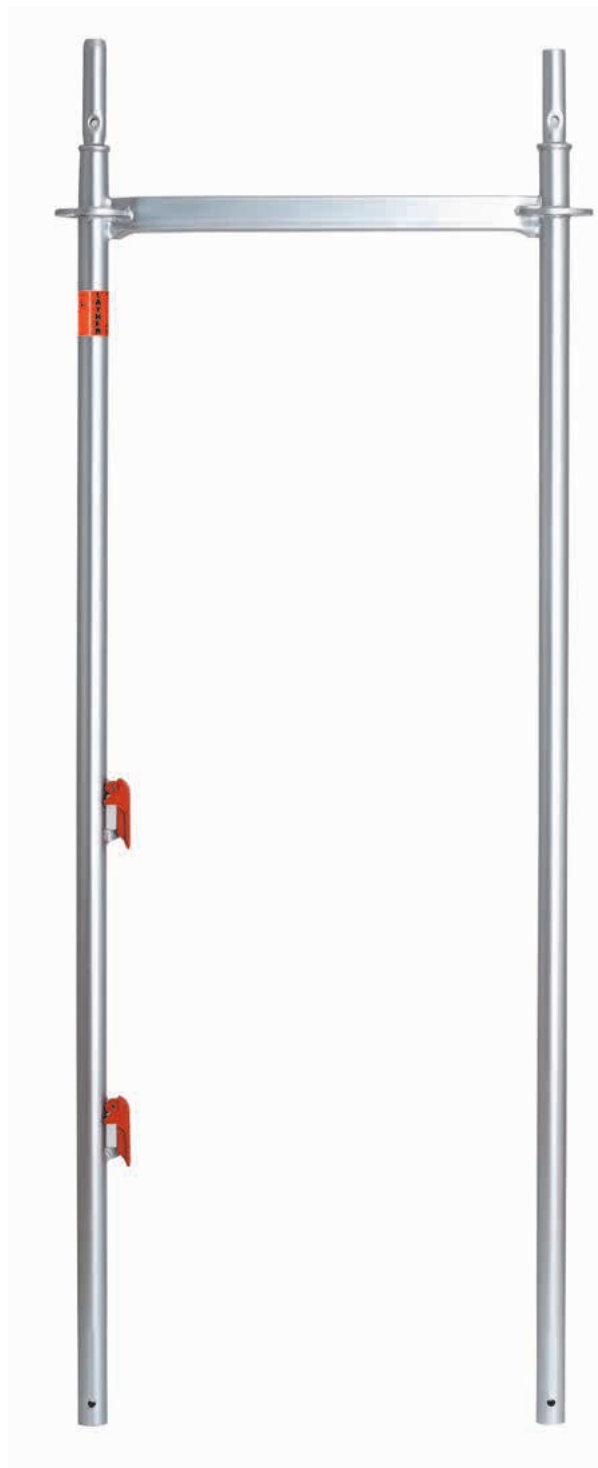



# FAST

// THANKS TO INGENUOUS CONNECTION ELEMENTS

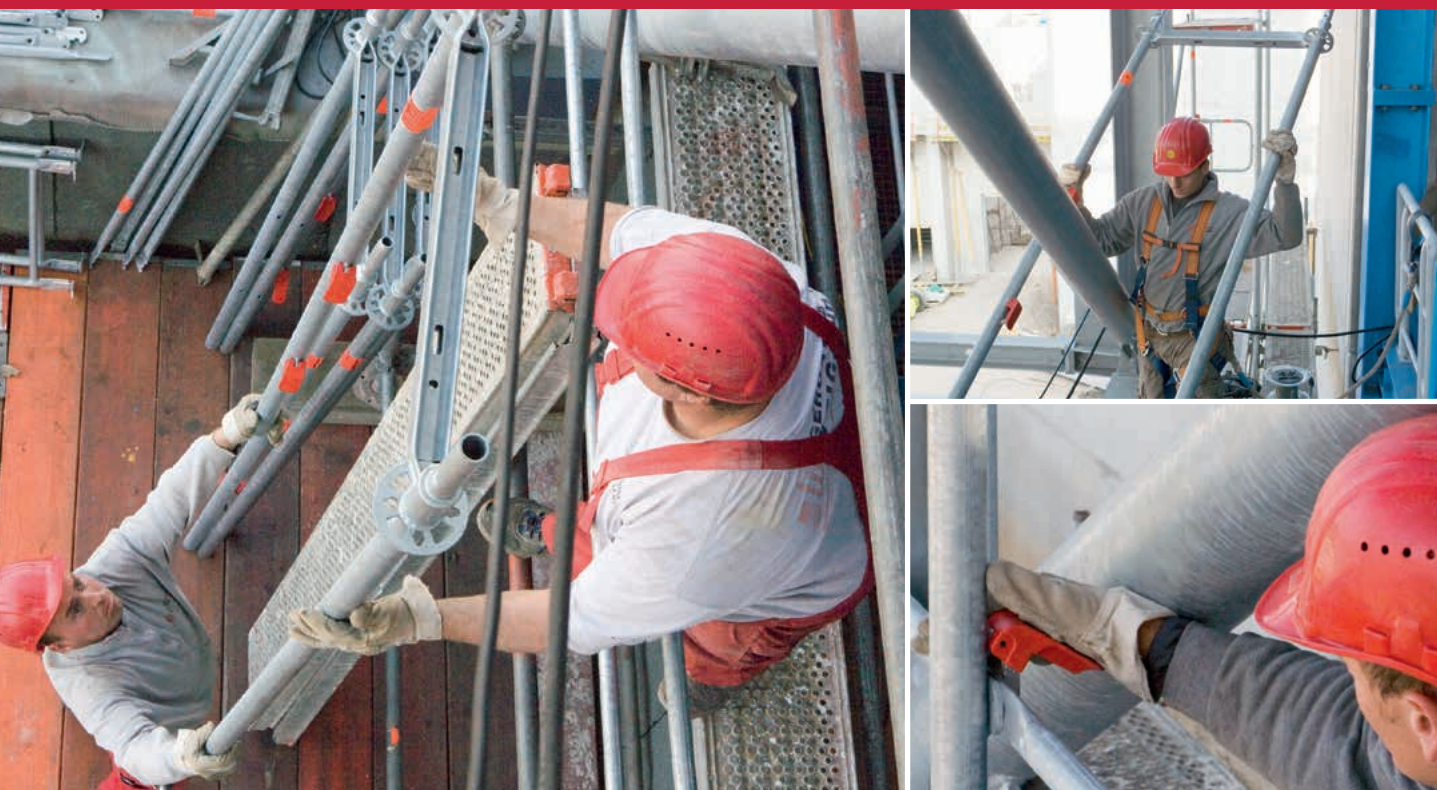

24 % TIME SAVING\*

## SMALL NUMBER OF PARTS

1 STAR frame replaces 2 Allround standards and 1 Allround ledger: that means faster assembly and fewer parts to be moved.

## GUARD RAIL ASSEMBLY WITHOUT TOOLS

Tool-free guardrail assembly ensures fast fitting and removal of the guardrails. The red bar shows even at a distance whether the guard-rail has been secured or not.

Allround Scaffolding

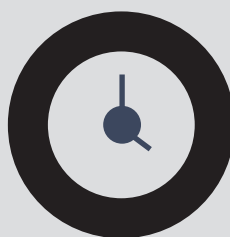

STAR frame

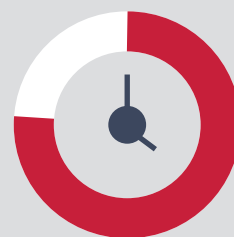

\* Ascertained by comparing assembly of an Allround façade scaffolding with a STAR façade scaffolding.



Position closed



Position opened

# LIGHT

// THANKS TO OPTIMIZED DESIGN



## 38 % WEIGHT SAVING\*

### LIGHTWEIGHT GUARDRAIL

Lightweight guardrail made of dia. 33.7 mm tube, while the verticals of the STAR frame are made of proven tube, 48.3 x 2.7 mm.

### LOW WEIGHT

The low weight of the STAR frame ensures fatigue-free working and hence faster assembly and dismantling, particularly in scaffolding over large areas.

### LOW TRANSPORT COSTS

The case of overload is decreasing. Higher amounts of material can be transported.

#### Allround Scaffolding



#### STAR frame



\* Applies for variant U. For variant O, weight saving is 42%.



#### Allround Scaffolding weight

2 Standards, 2.0 m	20.4 kg
1 U-ledger	3.1 kg
1 U-lift-off preventer	1.3 kg
2 O-ledgers	24.0 kg
<b>total</b>	<b>48.8 kg</b>



#### STAR frame weight

1 U-STAR frame	18.0 kg
1 STAR lift-off preventer	1.4 kg
2 STAR guardrails	11.0 kg
<b>total</b>	<b>30.4 kg</b>



# FLEXIBLE

// THANKS TO ENORMOUS VERSATILITY



## 100 % FLEXIBILITY

### OPEN FRAME

the frame, open underneath and without cross rung, permits fitting and removal of decks even if the scaffolding has already been erected. Decks can therefore – when it is not planned for the scaffolding to have decks on all levels – be moved around to keep pace with assembly progress.

### INTERNAL GUARDRAILS

Internal guardrails can be connected to the slots on the inside of the frame standard using the swivelling guardrail levers, quickly and without tools.

### COMPATIBILITY

Rosettes in the upper part of the STAR frame ensure compatibility with Allround and offer a wide range of connection possibilities.

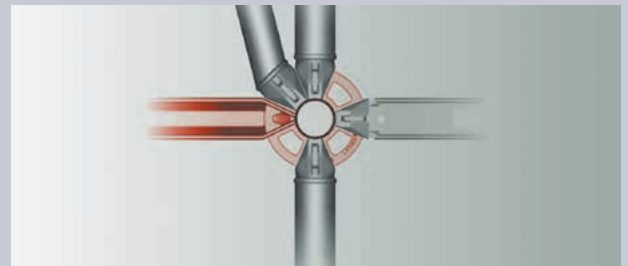

Rosettes in the upper part of the STAR frame ensure compatibility with Allround and offer a wide range of connection possibilities.



Adaptation to the ground using Allround



STAR with lattice beam as birdcage scaffolding



# STAR FRAME

// SIMPLY INNOVATIVE

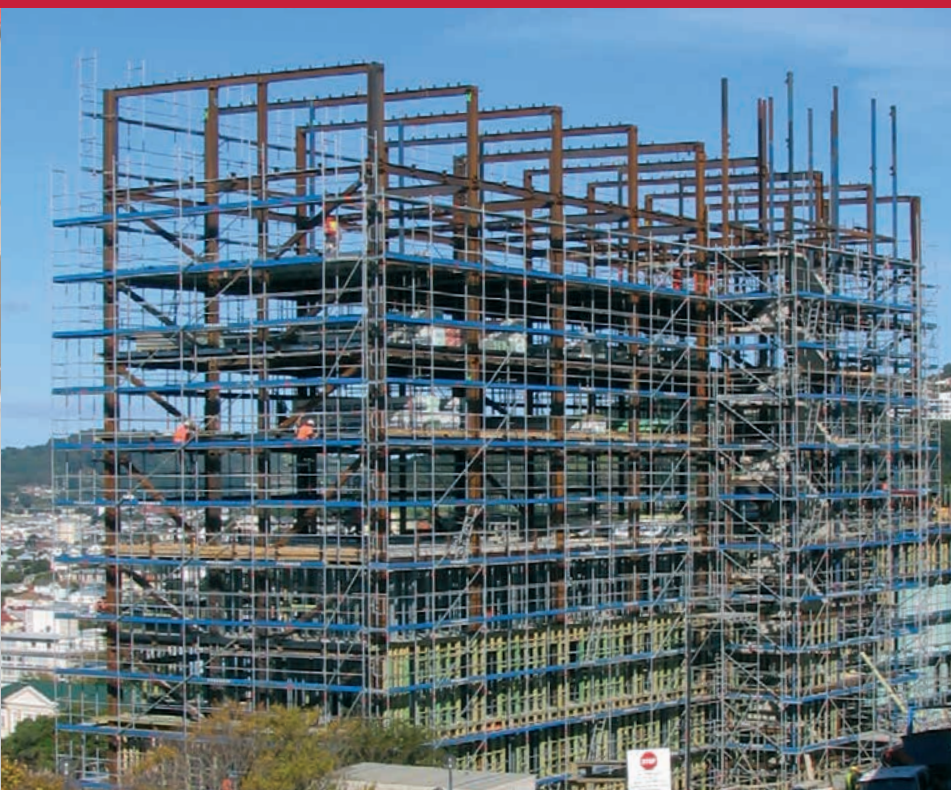



	SpeedyScaf
	Allround Scaffolding
	Accessories
	Protective Systems
	Shoring
	Event Systems
	Rolling Towers
	Ladders



// Proximity to the customer is a central factor behind Layher's success – geographically speaking too. Wherever our customers need us, we will be there – with our advice, assistance and solutions.



// Headquarters in Eibensbach



// Plant II in Gueglingen

// Layher is your dependable partner with more than 60 years of experience. "Made by Layher" always means "Made in Germany" too – and that goes for the entire product range. Superb quality – and all from one source.

**Layher** 

More Possibilities. The Scaffolding System.

**Wilhelm Layher GmbH & Co. KG**  
Scaffolding Grandstands Ladders

Ochsenbacher Strasse 56  
D-74363 Gueglingen-Eibensbach  
Germany

Post Box 40  
D-74361 Gueglingen-Eibensbach  
Germany  
Telephone +49 (0) 71 35 70-0  
Telefax +49 (0) 71 35 70-2 65  
E-Mail: [export@layher.com](mailto:export@layher.com)  
[www.layher.com](http://www.layher.com)

